

Solar PV-Powered SRM Drive based on Fuzzy logic controller for EVs with Flexible Energy Control Functions

G. VASAVI¹ M.PALLAVI²

PG Student / Dept. of Electrical & Electronics Engineering, Sri Padmavati Mahila Visvavidyalayam, Tirupati,
A.P. India¹

Assistant Professor / Dept. of Electrical & Electronics Engineering, Sri Padmavati Mahila Visvavidyalayam, Tirupati,
A.P. India²

ABSTRACT: In this paper Hybrid Electric vehicle (HEV) technology provides an effective solution for achieving higher fuel economy and better performances with reduced greenhouse gas emissions. For Electric vehicle applications, Switched reluctance motor (SRM) is the best suitable one of all the available motors. To increase the driving miles of the electric vehicles, a photovoltaic (PV) panel is mounted along with on-board battery bank. A tri-port converter with fuzzy logic controller is proposed in this paper to control the energy flow between the PV panel, battery and SRM drive. Six operational modes are presented, four of which are developed for driving modes and rest two for stand still on-board charging. In driving modes, the Perturb and observe technique is employed in order to receive maximum power from the PV panel.

KEYWORDS: Electric Vehicles, Photovoltaic (PV), Switched Reluctance Motors (SRMs), Tri-Port Converter, Perturb and Observe Technique, Fuzzy Logic Controller.

I. INTRODUCTION

Electric vehicles have taken a significant leap forward, by advances in motor drives, power converters, batteries and energy management systems [1]-[4]. Be that as it may, due to the limitation of current battery technologies, the driving miles is moderately short that limits the wide utilization of EVs [5]-[7]. In terms of motor drives, high-performance permanent-magnet (PM) machines are generally utilized while rare-earth materials are required in large quantities, restricting the wide utilization of EVs. Keeping in mind the end goal to defeat these issues, a photovoltaic panel and a switched reluctance motor (SRM) are introduced with give power supply and motor drive, respectively. Firstly, by including the PV panel on top of the EV, a sustainable energy source is achieved.

Nowadays, a typical passenger car has a surface enough to install a 250-W PV panel. Second, a SRM needs no rare-earth PMs and is additionally robust so it gets increasing attention in EV applications[8-12]. While PV panels have low power density for traction drives, they can be used to charge batteries the greater part of time. For the most part, the PV-fed EV has a comparable structure to the hybrid electrical vehicle, whose internal combustion engine(ICE) is supplanted by the PV panel. The PV-fed EV system is outlined in Fig. 1. Its key components include an off-board charging station, a PV, batteries and power converters[13-14]. In order to decrease the energy conversion processes, one approach is to upgrade the motor to include some on-board charging functions[15-17]. For example, paper[17] designs a 20-kW split-phase PM motor for EV charging, yet it endures from high harmonic contents in the back electromotive drive (EMF). Another solution depends on a traditional SRM. Paper[18] achieves on-board charging and power factor correction in a 2.3-kW SRM by utilizing machine windings as the input filter inductor. The concept of modular structure of driving topology is proposed in paper[19]. Based on intelligent power modules (IPM), a four-phase half bridge converter is utilized to achieve driving and grid-charging. In spite of the fact that modularization

International Journal of Innovative Research in Science, Engineering and Technology

(An ISO 3297: 2007 Certified Organization)

Website: www.ijirset.com

Vol. 6, Issue 8, August 2017

supports mass production, the utilization of half/full bridge topology reduces the system reliability (e.g. shoot-through issues). Paper[20] builds up a basic topology for plug-in hybrid electrical vehicle (HEV) that supports flexible energy flow. In any case, for grid charging, the grid should be associated with the generator rectifier that builds the energy conversion process and decreases the charging efficiency. In any case, a powerful topology and control strategy for PV-fed EVs is not yet developed. Since the PV has different characteristics to ICEs, the maximum power point tracking (MPPT) and solar energy utilization are the unique factors for the PV-fed EVs.

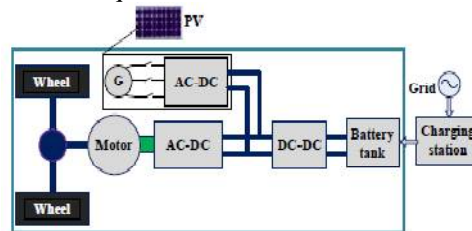

Fig. 1. PV-fed hybrid electrical vehicle.

In order to achieve low cost and flexible energy flow modes, a low cost tri-port converter is proposed in this paper to arrange the PV panel, SRM and battery. Six operational modes are developed to support flexible control of energy flow.

II. TOPOLOGY AND MODES OF OPERATION

A. Proposed topology and working modes

The proposed Tri-port topology has three energy terminals, PV, battery and SRM. They are linked by a power converter which comprises of four switching devices ($S_0 \sim S_3$), four diodes ($D_0 \sim D_3$) and two relays, as appeared in Fig. 2 [21]. By controlling relays J1 and J2, the six operation modes are upheld, as appeared in Fig. 3; the corresponding relay activities are delineated in Table I. In mode 1, PV is the energy source to drive the SRM and to charge the battery. In mode 2, the PV and battery are both the energy sources to drive the SRM. In mode 3, the PV is the source and the battery is idle. In mode 4, the battery is the driving source and the PV is idle. In mode 5, the battery is charged by a single-phase grid while both the PV and SRM are idle. In mode 6, the battery is charged by the PV and the SRM is idle.

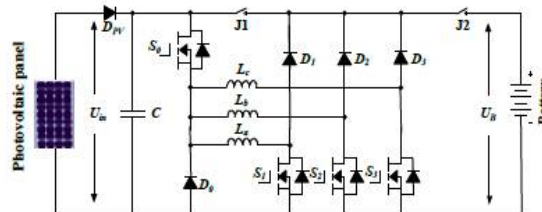

Fig. 2. The proposed Tri-port topology for PV-powered SRM drive.

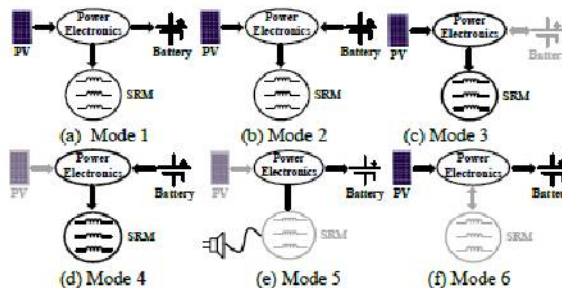

Fig. 3. Six operation modes of the proposed Tri-port topology.

International Journal of Innovative Research in Science, Engineering and Technology

(An ISO 3297: 2007 Certified Organization)

Website: www.ijirset.com

Vol. 6, Issue 8, August 2017

TABLE I J1 and J2 Actions under Different Modes

Mode	J1 and J2
1	J1 turn-off; J2 turn-on
2	J1 and J2 turn-on
3	J1 turn-on; J2 turn-off
4	J1 and J2 turn-on
5	J1 and J2 turn-on
6	J1 turn-off; J2 turn-on

B. Modes of Driving

Working modes 1~4 are the driving modes to give traction drive to the vehicle.

(1) Mode 1

At light loads of operation, the energy produced from the PV is more than the SRM required; the system works in mode 1. The corresponding operation circuit is appeared in Fig.4 (a), in which relay J1 turns off and relay J2 turns on. The PV panel energy feed the energy to SRM and charge the battery; so in this mode, the battery is charged in EV operation condition.

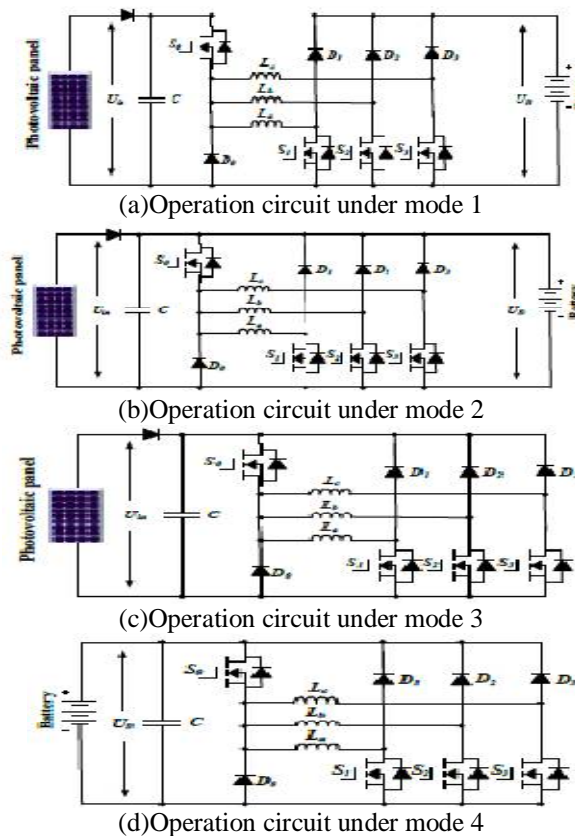

Fig. 4. The equivalent circuits under driving modes.

(2) Mode 2

At the point when the SRM operates in heavy load, for example, uphill driving or acceleration, both the PV panel and battery supply power to the SRM. The relating operation circuit is appeared in Fig. 4(b), in which relay J1 and J2 are turned on.

(3) Mode 3

At the point when the battery is out of power, the PV panel is the only energy source to drive the vehicle. The corresponding circuit is appeared in Fig. 4(c). J1 turns on and J2 turns off.

International Journal of Innovative Research in Science, Engineering and Technology

(An ISO 3297: 2007 Certified Organization)

Website: www.ijirset.com

Vol. 6, Issue 8, August 2017

(4) Mode 4

At the point when the PV can't generate electricity due to low solar irradiation, the battery supplies power to the SRM. The corresponding topology is delineated in Fig. 4(d). In this mode, relay J1 and J2 are both conducting.

C. Modes Of Charging

Operating modes 5 and 6 are the battery charging modes.

(5) Mode 5

At the point when PV can't generate electricity, an external powersource is expected to charge the battery, for example, AC grid. The relating circuit is appeared in Fig. 5(a). J1 and J2 turns on. Point A is central tapped of phase windings that can be effectively accomplished without changing the motor structure. One of the three phase windings is split and its midpoint is pulled out, as appeared in Fig. 5(a). Phase windings La1 and La2 are employed as inputfilter inductors. These inductors are a part of the drive circuit to form an AC-DC rectifier for grid charging.

(6) Mode 6

At the point when the EV is stopped under the sun, the PV can charge the battery. J1 turns off; J2 turns on. The relating charging circuit is appeared in Fig. 5(b).

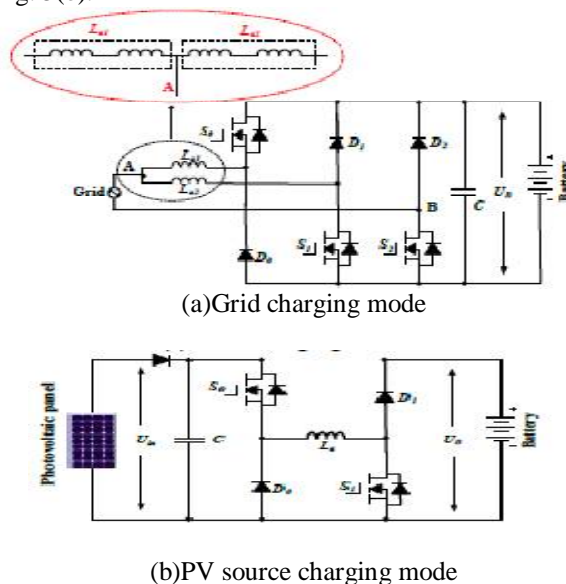

Fig. 5. Equivalent circuits of charging condition modes.

III. CONTROL STRATEGY FOR ALL MODES

In order to make the best utilization of sun oriented energy for driving the EV, a control strategy under various modes is planned.

A. Single source driving mode

As indicated by the distinction in the power sources, there are PV-driving; battery-driving and PV and battery parallel fed source. In a heavy load condition, the PV power can't support the EV, mode 2 can be adopted to support enough energy and make full utilization of solar energy. Fig. 6(a) demonstrates the equivalent power source; the corresponding PV panel working points is represented in Fig. 6(b). Since the PV is paralleled with the battery, the PV panel voltage is clamped to the battery voltage U_B . In mode 2, there are three working states: winding excitation, energy recycling and freewheeling states, as appeared in Fig. 7. Modes 3 and 4 have comparable working states to mode 2. The difference is that the PV is the only source in mode 3 while the battery is the only source in mode 4.

International Journal of Innovative Research in Science, Engineering and Technology

(An ISO 3297: 2007 Certified Organization)

Website: www.ijirset.com

Vol. 6, Issue 8, August 2017

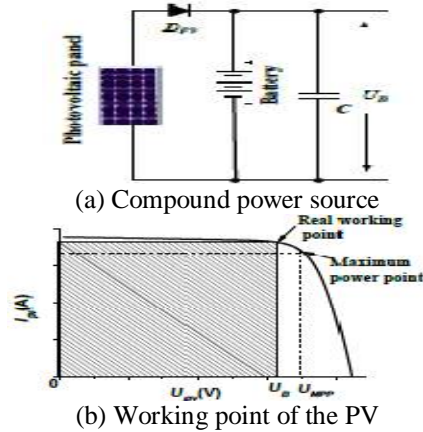

Fig. 6. Power supply at mode 2.

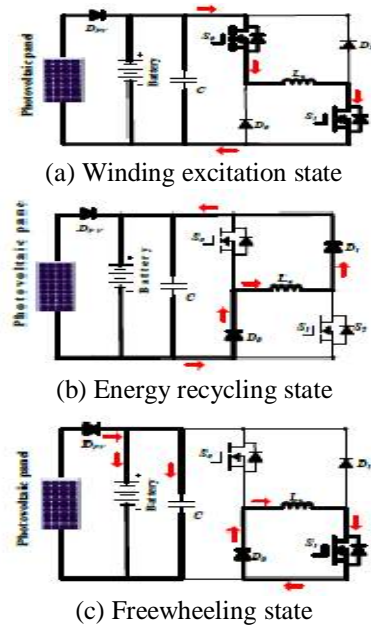

Fig. 7. Working states at mode 2.

Neglecting the voltage drop over the power switches and diodes, the phase voltage is given by

$$U_{in} = R_k i_k + \frac{d\psi(i_k, \theta_r)}{dt}$$

$$= R_k i_k + L_k \frac{di_k}{dt} + i_k \omega_r \frac{dL_k}{d\theta_r}, \quad k=a,b,c(1)$$

where U_{in} is the DC-link voltage, k is phase a, b, or c, R_k is the phase resistance, i_k is the phase current, L_k is the phase inductance, θ_r is the rotor position, $\psi(i_k, \theta_r)$ is the phase flux linkage depending upon the phase current and rotor position, and ω_r is the angular speed.

The third term in Eq. 1 is the back electromotive force (EMF) voltage by

$$e_k = i_k \omega_r \frac{dL_k}{d\theta_r} (2)$$

International Journal of Innovative Research in Science, Engineering and Technology

(An ISO 3297: 2007 Certified Organization)

Website: www.ijirset.com

Vol. 6, Issue 8, August 2017

Consequently, the phase voltage is found by

$$U_k = R_k i_k + L_k \frac{di_k}{dt} + e_k \quad (3)$$

In the excitation area, turning on S_0 and S_1 will induce a current in phase a winding, as show in Fig. 7(a). Phase a winding is subjected to the positive DC bus voltage.

$$+ U_{in} = R_k i_k + L_k \frac{di_k}{dt} + e_k \quad (4)$$

At the point when S_0 is off and S_1 is on, the phase current is in a freewheeling state in a zero voltage loop, as appeared in Fig. 7(c), the phase voltage is zero.

$$0 = R_k i_k + L_k \frac{di_k}{dt} + e_k \quad (5)$$

In the demagnetization region, S_0 and S_1 are both turned off; what's more, the phase current will flow back to the power supply, as appear in Fig. 7(b). In this state, the phase winding is subjected to the negative DC bus voltage, and the phase voltage is

$$-U_{in} = R_k i_k + L_k \frac{di_k}{dt} + e_k \quad (6)$$

In single source driving mode, the voltage-PWM control is utilized as the fundamental plan, as showed in Fig. 8. As per the given speed ω^* , the voltage-PWM control is activated at speed control.

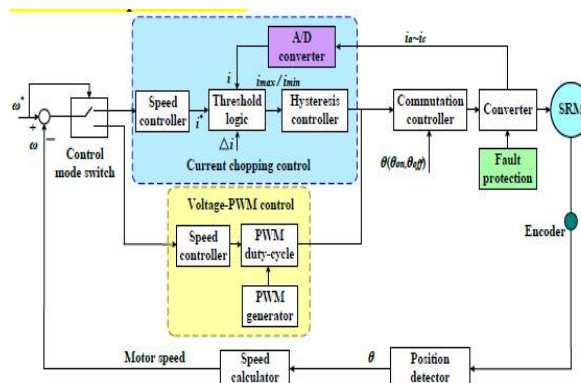
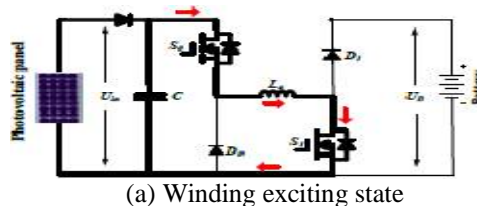

Fig. 8. SRM control strategy under single source driving mode.

B. Driving-charging hybrid control strategy

In the driving-charging hybrid control, the PV is the driving source and the battery is charged by the freewheeling current, as represented in drive mode 1. There are two control targets: maximum power point tracking (MPPT) of the PV panel and speed control of the SRM. The dual-source condition is switched from a PV-driving mode. Firstly, the motor speed is controlled at a given speed in mode 3. At that point, J_2 is turned on and J_1 is off to switch to mode 1. By controlling the turn-off point, the maximum power of PV panel can be tracked. There are three steady working states for the double source (mode 1), as appeared in Fig. 9. In Fig. 9(a), S_0 and S_1 conduct, the PV panel charges the SRM winding to drive the motor; In Fig. 9(b), S_0 and S_1 turn off; and the battery is charged with freewheeling current of the phase winding. Fig. 9(c) appears a freewheeling state.



(a) Winding exciting state

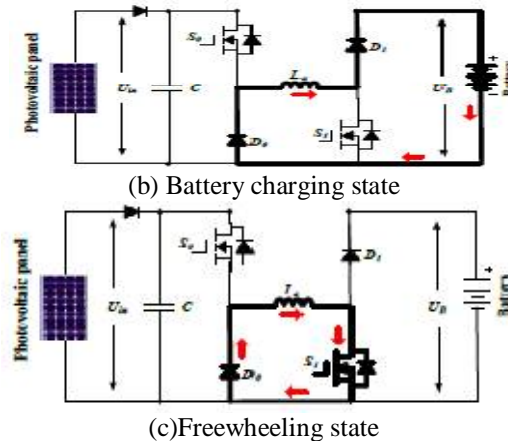

Fig. 9. Mode 1 working states.

Fig.10 is the control strategy under driving-charging mode. In Fig.10, θ_{on} is the turn on angle of SRM; θ_{off} is the turn-off angle of SRM. By changing turn-on angle, the speed of SRM can be controlled; the maximum power point tracking of PV panel can be achieved by adjusting turn-off angle, which can control the charging current to the battery.

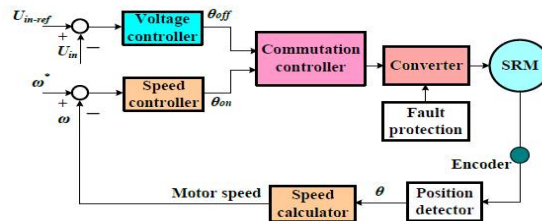

Fig. 10. Control strategy under driving-charging mode (mode 1)

C. Grid-charging control system

The proposed topology also supports the single-phase grid charging. There are four fundamental charging states and S_0 is dependably turned off. At the point when the grid instantaneous voltage is more than zero, the two working states are exhibited in Fig. 11(a) and (b). In Fig. 11(a), S_1 and S_2 conduct, the grid voltage charges the phase winding L_{a2} , the relating condition can be communicated as Eq.7; In Fig. 11(b), S_1 turns off and S_2 conducts, the grid is associated in series with phase winding to charges the battery, the relating condition can be communicated as Eq. 8.

$$U_{grid} = L_{a2} \cdot \frac{di_{grid}}{dt} \quad (7)$$

$$U_B - U_{grid} = L_{a2} \cdot \frac{di_{grid}}{dt} \quad (8)$$

At the point when the grid instantaneous voltage is below zero, the two working states are introduced in Fig. 11(c) and (d). In Fig. 11(c), S_1 and S_2 conduct, the grid voltage charges the phase winding L_{a1} and L_{a2} , the comparing condition can be communicated as Eq. (9); In Fig. 11(d), S_1 continues conducting and S_2 turns off, the grid is associated in series with phase winding L_{a1} and L_{a2} to charges the battery, the relating condition can be communicated as Eq. 10.

$$U_{grid} = \frac{L_{a1} + L_{a2}}{L_{a1} \cdot L_{a2}} \cdot \frac{di_{grid}}{dt} \quad (9)$$

$$-U_B - U_{grid} = \frac{L_{a1} + L_{a2}}{L_{a1} \cdot L_{a2}} \cdot \frac{di_{grid}}{dt} \quad (10)$$

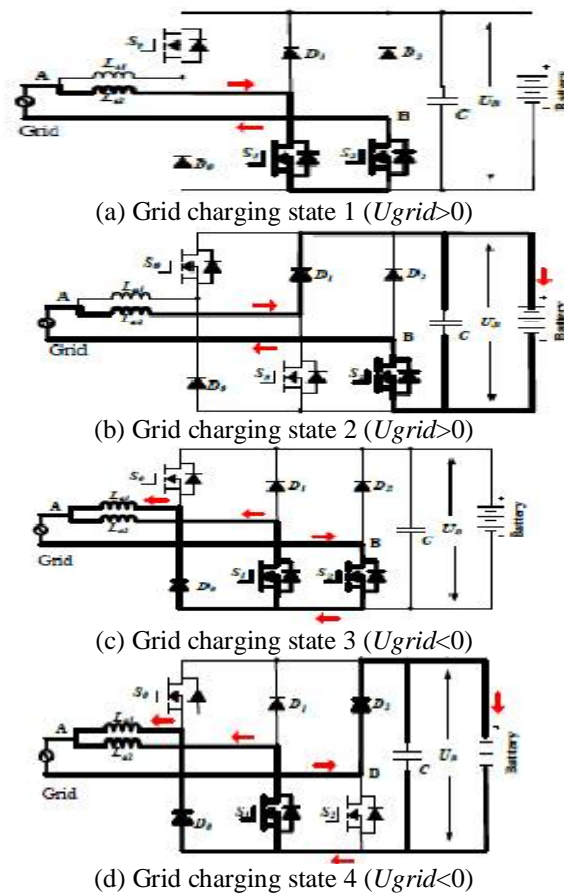

Fig.11. Mode 5 charging states.

In Fig. 12, U_{grid} is the grid voltage; by the phase lock loop (PLL), the phase data can be got; I_{ref_grid} is the given amplitude of the grid current. Combining $\sin\theta$ and I_{ref_grid} , the instantaneous grid current reference i_{ref_grid} can be figured. In this mode, when $U_{grid} > 0$, the inductance is L_{a2} ; when $U_{grid} < 0$, the inductance is paralleled L_{a1} and L_{a2} ; so in order to adopt the change in the inductance, hysteresis control is employed to acknowledge grid current regulation. Besides, hysteresis control has great loop performance, global stability and small phase lag that makes grid connected control stable

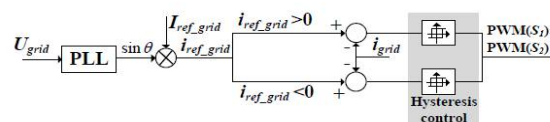

Fig. 12. Grid-connected charging control (Mode 5).

D. PV-fed charging control system

In this mode, the PV panel charges the battery specifically by the driving topology. The phase windings are employed as inductor; what's more, the driving topology can be worked as interleaved Buckboost charging topology. For one phase, there are two states, as appeared in Fig. 13(a) and (b). Whenever S_0 and S_1 turn on, the PV panel charges phase inductance; when S_0 and S_1 turns off, the phase inductance discharges energy to battery. According to the state-of-charging (SoC), there are three stages to make full utilize of solar energy and keep up battery healthy

International Journal of Innovative Research in Science, Engineering and Technology

(An ISO 3297: 2007 Certified Organization)

Website: www.ijirset.com

Vol. 6, Issue 8, August 2017

condition, as represented in Fig.13 (c). During stage 1, the relating battery SoC is in 0~SoC1, the battery is in greatly need energy condition, the MPPT control strategy is utilized to make full utilization of solar energy. During stage 2, the corresponding battery SoC is in SoC1~ SoC2, the constant voltage control is adapted to charging the battery. During stage 3, the corresponding battery SoC is in SoC2~1, the micro current charging is adapted. In order to simplify the control strategy, constant voltage is employed in PV panel MPPT control.

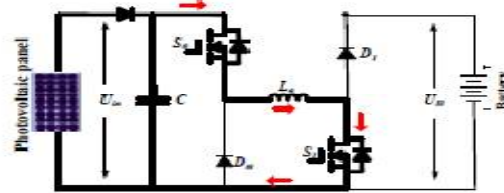

(a) Phase inductance charging

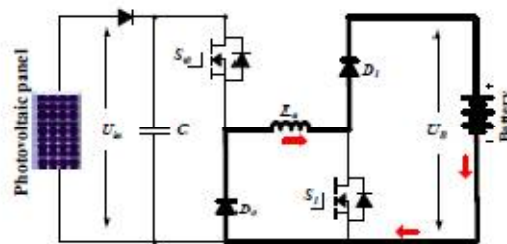

(b) Battery charging

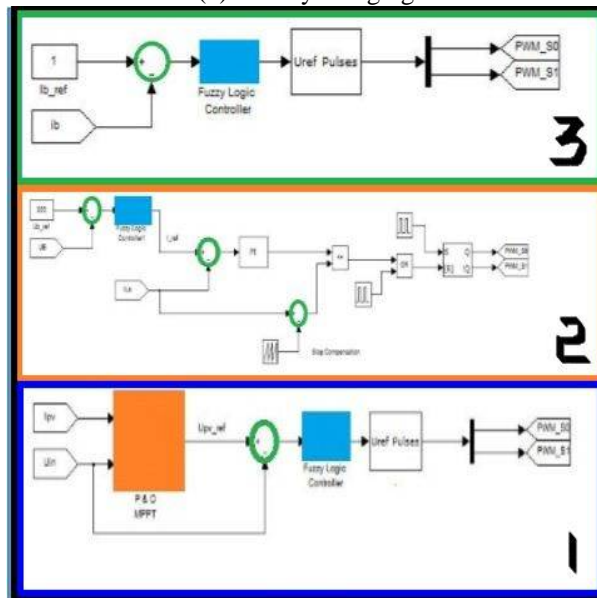

(c) Charging control strategy.

Fig. 13. Mode 6 charging states and control strategy.

Extension:

Fuzzy Logic System:

Today control systems are usually described by mathematical models that follow the laws of physics, stochastic models or models which have emerged from mathematical logic. A general difficulty of such constructed model is how to move from a given problem to a proper mathematical model. Undoubtedly, today's advanced computer technology makes it possible; however managing such systems is still too complex.

International Journal of Innovative Research in Science, Engineering and Technology

(An ISO 3297: 2007 Certified Organization)

Website: www.ijirset.com

Vol. 6, Issue 8, August 2017

These complex systems can be simplified by employing a tolerance margin for a reasonable amount of imprecision, vagueness and uncertainty during the modeling phase. As an outcome, not completely perfect system comes to existence; nevertheless in most of the cases it is capable of solving the problem in appropriate way. Even missing input information has already turned out to be satisfactory in knowledge-based systems.

Fuzzy logic allows to lower complexity by allowing the use of imperfect information in sensible way. It can be implemented in hardware, software, or a combination of both. In other words, fuzzy logic approach to problems' control mimics how a person would make decisions, only much faster.

In order to operate fuzzy logic needs to be represented by numbers or descriptions. For example, speed can be represented by value 5 m/s or by description "slow". Term "slow" can have different meaning if used by different persons and must be interpreted with respect to the observed environment. Some values are easy to classify, while others can be difficult to determine because of human understanding of different situations. One can say "slow", while other can say "not fast" when describing the same speed. These differences can be distinguished with help of so-called fuzzy sets.

Usually fuzzy logic control system is created from four major elements presented on Figure 1: fuzzification interface, fuzzy inference engine, fuzzy rule matrix and defuzzification interface. Each part along with basic fuzzy logic operations will be described in more detail below[22].

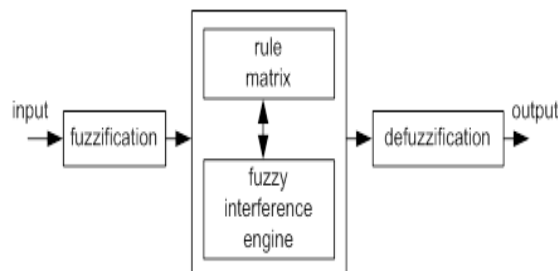

Fig. 14. Fuzzy logic controller

Advantages of Fuzzy Controller over PI Controller:

The PI controller requires precise linear mathematical models, which are difficult to obtain and may not give satisfactory performance under parameter variations, load disturbances, etc. Recently, Fuzzy Logic Controllers (FLCs) have been introduced in various applications and have been used in the power electronics field. The advantages of fuzzy logic controllers over conventional PI controllers are that they do not need an accurate mathematical model, Can work with imprecise inputs and Can handle non-linearities and are more robust than conventional PI controllers.

IV. SIMULATION

A 12/8 SRM is initially modeled in Matlab/Simulink utilizing parameters in Table II. Fig. 15(a) presents the simulation results at mode 1. The load torque is set as 35 Nm, the PV panel voltage is controlled at the MPP. The freewheeling current is used to charge the battery. Fig. 15(b) demonstrates the simulation results of the single-source driving (modes 2-4).

Parameter	Value
SRM	6/4
PV panel	310V
Maximum Power point voltage reference voltage	
Battery voltage	350V
Constant voltage control reference voltage	355V
Constant current control reference current	1A
Mode1, charging current	60A
Mode4, driving speed	1250rpm
Mode6, constant voltage charging reference	355V
Mode6, constant current charging reference	1A

Table II: Simulation Parameters

International Journal of Innovative Research in Science, Engineering and Technology

(An ISO 3297: 2007 Certified Organization)

Website: www.ijirset.com

Vol. 6, Issue 8, August 2017

Fig. 16 demonstrates the simulation results of charging where Fig. 16(a) is for grid-charging. The positive half current quality is superior to anything the negative half that is caused by the change in the grid-connected inductance. Fig. 16(b) and (c) are for PV-charging. Fig. 16(b) presents the step change from stage 1 to 2. In stage 1, the battery is low in SoC. In order to achieve MPPT of the PV, the constant voltage control is utilized and the PV output voltage is controlled at MPP (310 V), as appeared in Fig. 16(b). In stage 2, a constant voltage is embraced; the reference voltage is set to 355 V. As appeared in Fig. 16(b), the charging converter output voltage is controlled at reference voltage in the step change from stage 1 to stage 2. In stage 3, 1 A trickle charging is moreover accomplished, as appeared in Fig. 16(c).

Mode 1

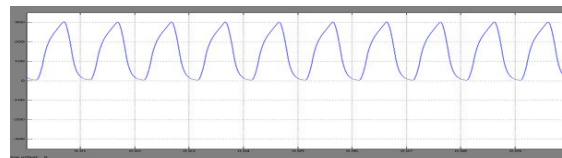

$I_a(A)$

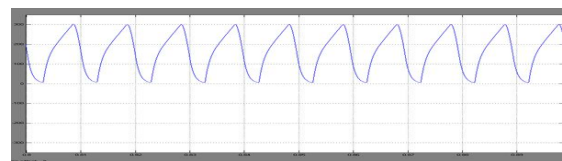

$I_b(A)$

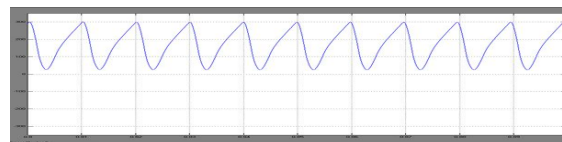

$I_c(A)$

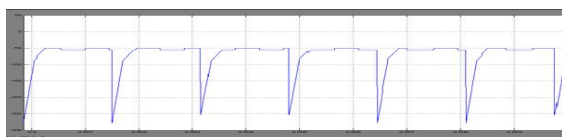

$I_{by}(A)$

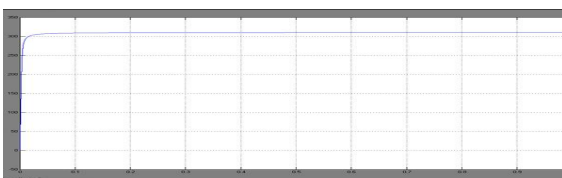

$U_{in}(V)$

(a) Simulation results of driving-charging mode (mode 1)

Mode3

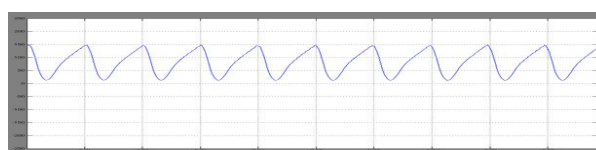

$I_{la}(A)$

International Journal of Innovative Research in Science, Engineering and Technology

(An ISO 3297: 2007 Certified Organization)

Website: www.ijirset.com

Vol. 6, Issue 8, August 2017

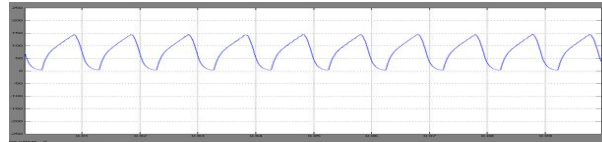

I_b (A)

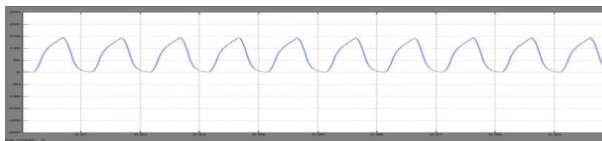

I_c (A)

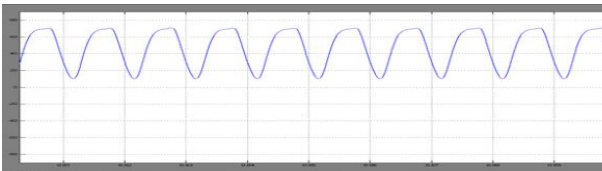

Torque(Nm)

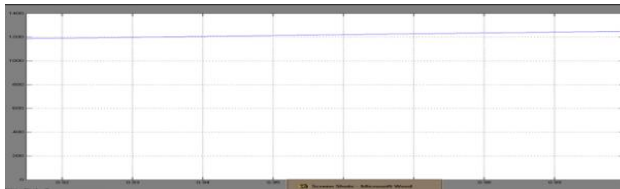

Speed(rpm)

(b) Simulation results of single source driving mode (modes 3)

Fig. 15. Simulation results for driving conditions at modes 1, 3 and 4.

Mode 5

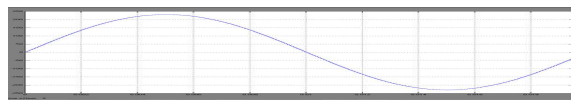

U_{grid} (V)

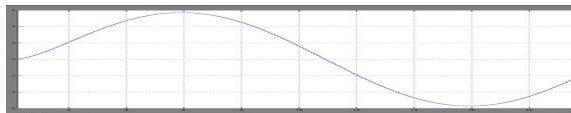

I_{grid} (A)



PWM_S1

International Journal of Innovative Research in Science, Engineering and Technology

(An ISO 3297: 2007 Certified Organization)

Website: www.ijirset.com

Vol. 6, Issue 8, August 2017

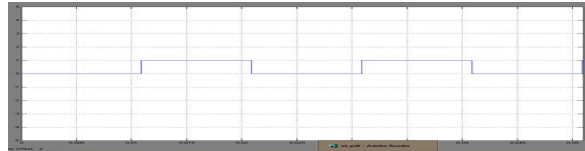

PWM_S2

(a) Grid charging (mode 5)

Mode6_Stage1

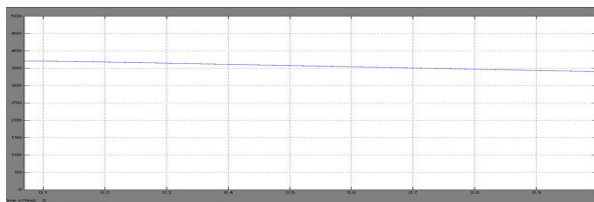

U_b (V)

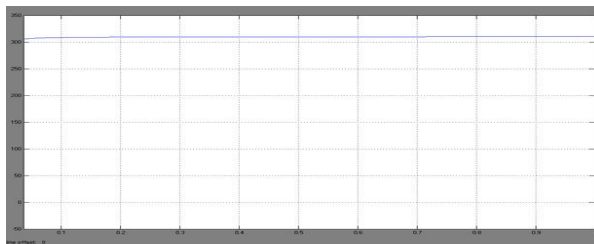

U_{in} (V)

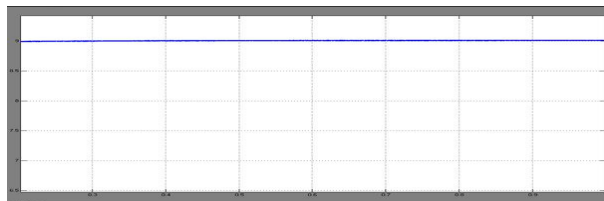

I_a (A)

(b) PV charging mode 6 (stage 1)

Mode6_Stage2

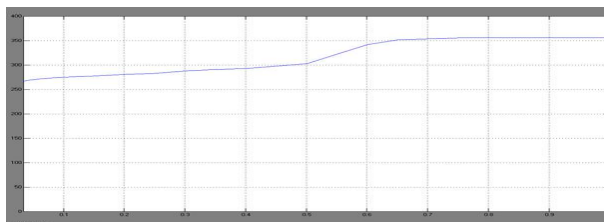

U_b (V)

International Journal of Innovative Research in Science, Engineering and Technology

(An ISO 3297: 2007 Certified Organization)

Website: www.ijirset.com

Vol. 6, Issue 8, August 2017

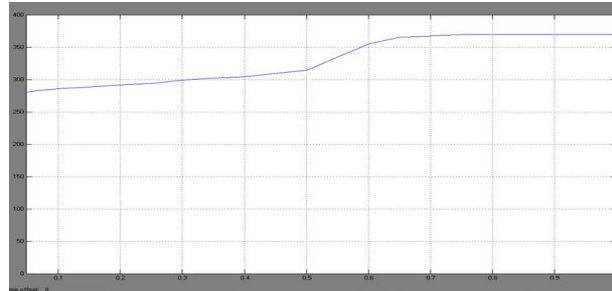

U_{in} (V)

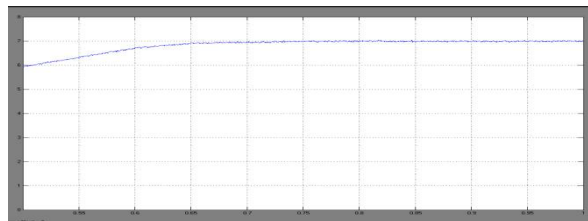

I_a (A)

(c) PV charging mode 6 (stage 2)

Mode6_Stage3

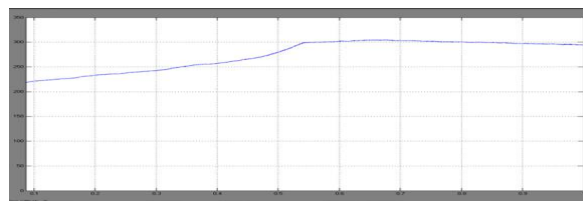

U_b (V)

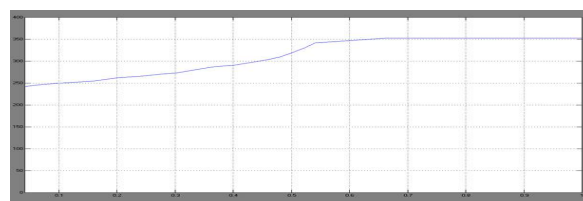

U_{in} (V)

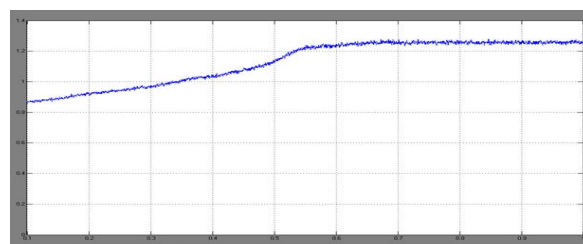

I_{by} (A)

International Journal of Innovative Research in Science, Engineering and Technology

(An ISO 3297: 2007 Certified Organization)

Website: www.ijirset.com

Vol. 6, Issue 8, August 2017

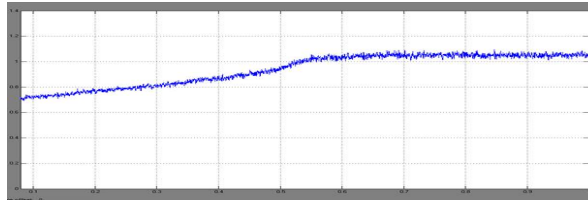

I_a (A)

(d)PV charging mode 6 (stage 3)

Fig. 16. simulation results for charging modes.

THD in % proposed method	THD in % extension method
Mode 1: $I_a=41.43, I_b=38.12,$ $I_c=64.58$	Mode 1: $I_a=25.72, I_b=19.82, I_c=27.17$
Mode 2: $I_a=43, I_b=31.01, I_c=71.52$	Mode 2: $I_a= 25.29 , I_b =14.46, I_c=27.94$
Mode 3: $I_{La}=82.66, I_{Lb}=33.68,$ $I_{Lc}=43.47$	Mode 3: $I_{La}=51.25, I_{Lb}=17.51, I_{Lc}=18.26$
Mode 4: $I_{La}= 64.68, I_{Lb} =34.25,$ $I_{Lc}=41.87$	Mode 4: $I_{La}= 40.1, I_{Lb} =17.51,$ $I_{Lc}=17.56$
Mode 5: $U_{grid}=0.004535,$ $I_{grid}=0.004864$	Mode 5: $U_{grid}=0.004535,$ $I_{grid}=0.004864$
Mode 6:stage 1 $I_a= 11.5$	Mode 6:stage 1 $I_a= 5.982$
Mode 6:stage 2 $I_a= 2.377$	Mode 6:stage 2 $I_a= 0.9985$
Mode 6:stage 3 $I_a= 2.429, I_{by}=2.632$	Mode 6:stage 3 $I_a= 1.815, I_{by}=1.989$

TableIII: THD values for Proposed and Extension methods.

V. CONCLUSION

In order to handle the range anxiety of utilizing EVs and decrease the system cost, a mix of the PV panel and SRM is proposed as the EV driving system.

The main contributions of this paper are:

International Journal of Innovative Research in Science, Engineering and Technology

(An ISO 3297: 2007 Certified Organization)

Website: www.ijirset.com

Vol. 6, Issue 8, August 2017

- (i) A tri-port converter is utilized to coordinate the PV panel, SRM and battery.
 - (ii) Six working modes are developed to achieve flexible energy flow for driving control, driving/charging hybrid control and charging control.
 - (iii) A novel grid-charging topology is formed without a need for external power electronics devices.
 - (iv) A PV-fed battery charging control scheme is developed to enhance the solar energy utilization.
- Since PV-fed EVs are a greener and more economical innovation than conventional ICE vehicles, this work will give feasible solution to reducing the total costs and CO₂ emissions of electrified vehicles. By using different control strategies in each mode and using fuzzy logic controller we can reduce the Total Harmonic Distortion to some extent. Moreover, the proposed innovation may likewise be connected to comparable applications, such as fuel cell powered EVs. Fuel cells have a considerably higher power density and are hence more qualified for EV applications.

REFERENCES

- [1] A. Emadi, L. Young-Joo, K. Rajashekara, "Power electronics and motor drives in electric, hybrid electric, and plug-in hybrid electric vehicles," IEEE Trans. Ind. Electron., vol. 55, no. 6, pp. 2237-2245, Jun. 2008.
- [2] B. I. K. Bose, "Global energy scenario and impact of power electronics in 21st century," IEEE Trans. Ind. Electron., vol. 60, no. 7, pp. 2638-2651, Jul. 2013.
- [3] J. de Santiago, H. Bernhoff, B. Ekegård, S. Eriksson, S. Ferhatovic, R. Waters, and M. Leijon, "Electrical motor drivelines in commercial all-electric vehicles: a review," IEEE Trans. Veh. Technol., vol. 61, no. 2, pp. 475-484, Feb. 2012.
- [4] Z. Amjadi, S. S. Williamson, "Power-electronics-based solutions for plug-in hybrid electric vehicle energy storage and management systems," IEEE Trans. Ind. Electron., vol. 57, no. 2, pp. 608-616, Feb. 2010.
- [5] A. Kuperman, U. Levy, J. Goren, A. Zafransky, and A. Savernin, "Battery charger for electric vehicle traction battery switch station," IEEE Trans. Ind. Electron., vol. 60, no. 12, pp. 5391-5399, Dec. 2013.
- [6] S. G. Li, S. M. Sharkh, F. C. Walsh, and C. N. Zhang, "Energy and battery management of a plug-in series hybrid electric vehicle using fuzzy logic," IEEE Trans. Veh. Technol., vol. 60, no. 8, pp. 3571-3585, Oct. 2011.
- [7] C. H. Kim, M. Y. Kim, and G. W. Moon, "A modularized charge equalizer using a battery monitoring IC for series-connected Li-Ion battery Strings in electric vehicles," IEEE Trans. Power Electron., vol. 28, no. 8, pp. 3779-3787, May 2013.
- [8] S. M. Yang, and J. Y. Chen, "Controlled dynamic braking for switched reluctance motor drives with a rectifier front end," IEEE Trans. Ind. Electron., vol. 60, no. 11, pp. 4913-4919, Nov. 2013.
- [9] B. Bilgin, A. Emadi, M. Krishnamurthy, "Comprehensive evaluation of the dynamic performance of a 6/10 SRM for traction application in PHEVs," IEEE Trans. Ind. Electron., vol. 60, no. 7, pp. 2564-2575, July. 2013.
- [10] M. Takeno, A. Chiba, N. Hoshi, S. Ogasawara, M. Takemoto, M. A. Rahman, "Test results and torque improvement of the 50-kW switched reluctance motor designed for hybrid electric vehicles," IEEE Trans. Ind. Appl., vol. 48, no. 4, pp. 1327-1334, Jul/Aug. 2012.
- [11] A. Chiba, M. Takeno, N. Hoshi, M. Takemoto, S. Ogasawara, M. A. Rahman, "Consideration of number of series turns in switched-reluctance traction motor competitive to HEV IPMSM," IEEE Trans. Ind. Appl., vol. 48, no. 6, pp. 2333-2340, Nov/Dec. 2012.
- [12] I. Boldea, L. N. Tutelea, L. Parsa, and D. Dorrell, "Automotive electric propulsion systems with reduced or no permanent magnets: an overview," IEEE Trans. Ind. Electron., vol. 60, no. 9, pp. 5696-5710, Oct. 2014.
- [13] Y. J. Lee, A. Khaligh, A. Emadi, "Advanced integrated bidirectional AC/DC and DC/DC converter for plug-in hybrid electric vehicles," IEEE Trans. Veh. Technol., vol. 58, no. 8, pp. 3970-3980, Oct. 2009.
- [14] M. Yilmaz, P.T. Krein, "Review of battery charger topologies, charging power levels, and infrastructure for plug-in electric and hybrid vehicles," IEEE Trans. Power Electron., vol. 28, no. 5, pp. 2151-2169, May 2013.
- [15] S. Haghbin, S. Lundmark, M. Alakula, and O. Carlson, "Grid-connected integrated battery chargers in vehicle applications: review and new solution," IEEE Trans. Ind. Electron., vol. 60, no. 2, pp. 459-473, Feb. 2013.
- [16] S. Haghbin, S. Lundmark, M. Alakula, and O. Carlson, "An isolated high power integrated charger in electrified-vehicle applications," IEEE Trans. Veh. Technol., vol. 60, no. 9, pp. 4115-4126, Nov. 2011.
- [17] S. Haghbin, K. Khan, S. Zhao, M. Alakula, S. Lundmark, O. Carlson, "An integrated 20-kW motor drive and isolated battery charger for plug-in vehicles," IEEE Trans. Power Electron., vol. 28, no. 8, pp. 4013-4029, Aug. 2013.
- [18] H. C. Chang, C. M. Liaw, "Development of a compact switched-reluctance motor drive for EV propulsion with voltage-boosting and PFC charging capabilities," IEEE Trans. Veh. Technol., vol. 58, no. 7, pp. 3198-3215, Sept. 2009.
- [19] H. C. Chang, C. M. Liaw, "An integrated driving/charging switched reluctance motor drive using three-phase power module," IEEE Trans. Ind. Electron., vol. 58, no. 5, pp. 1763-1775, May 2011.
- [20] Y. Hu, X. Song, W. Cao, B. Ji, "New SR drive with integrated charging capacity for plug-in hybrid electric vehicles (PHEVs)," IEEE Trans. Ind. Electron., vol. 61, no. 10, pp. 5722-5731, Oct. 2014.
- [21] Y. Hu, C. Gan, W. Cao, S. Finney, "Tri-port converter for flexible energy control of PV-fed electric vehicles", the IEEE International Electric Machines & Drives Conference (IEMDC 2015), May 10-13, 2015, Idaho, USA.
- [22] Speed Controller of Switched Reluctance Motor Indian Journal of Science and Technology, Vol 7(8), 1043-1048, August 2014